

**Most
Dependable
Fountains, Inc.**

OPERATIONS MANUAL

**MODEL:
2493 SMSS**

Most Dependable Fountains, Inc[™]
5705 Commander Drive
Arlington, TN 38002
901-867-0039
www.mostdependable.com

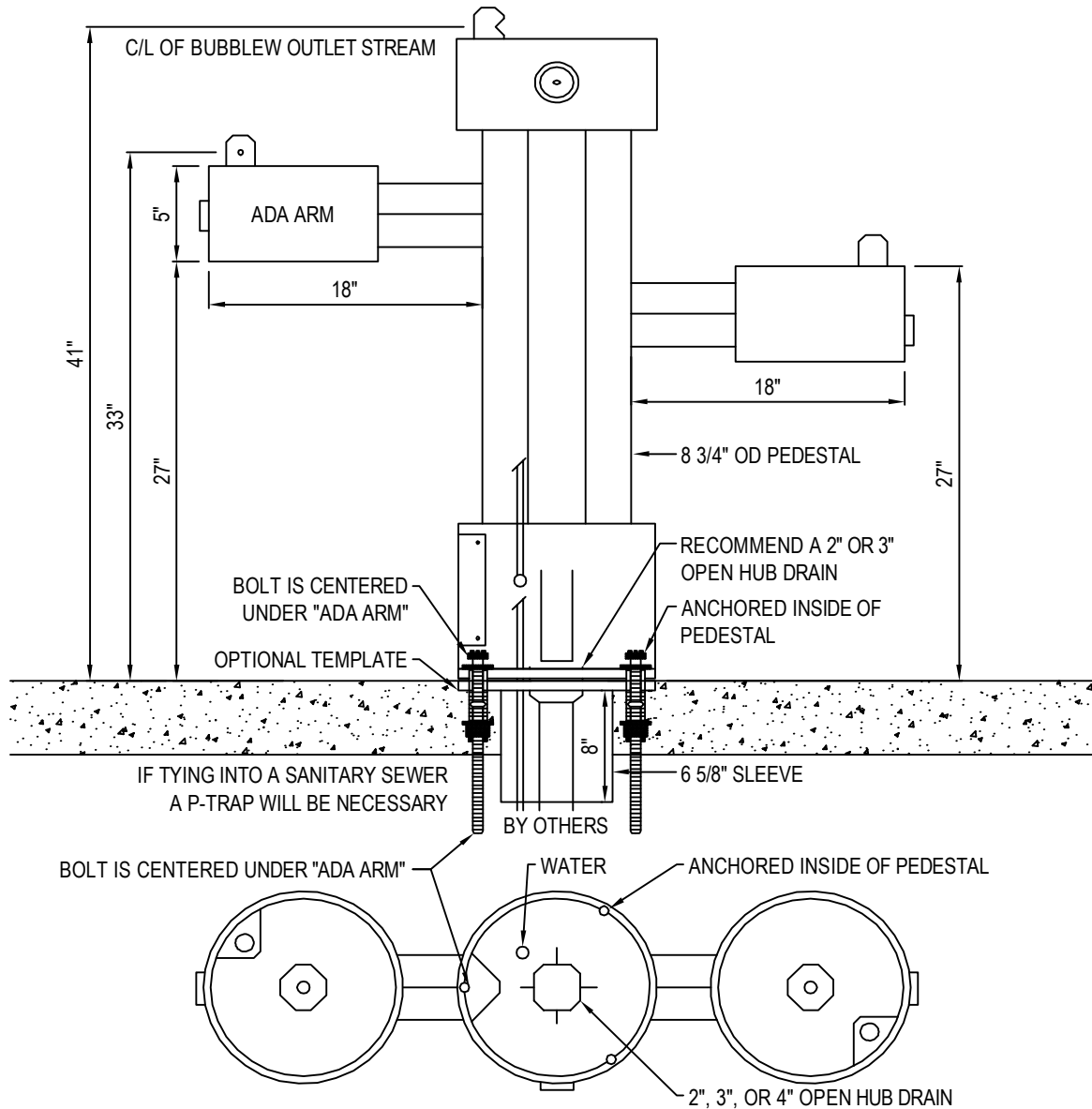

NOTES:

1. INSTALLATION TO BE COMPLETED IN ACCORDANCE WITH MANUFACTURER'S SPECIFICATIONS.
2. DO NOT SCALE DRAWING.
3. THIS DRAWING IS INTENDED FOR USE BY ARCHITECTS, ENGINEERS, CONTRACTORS, CONSULTANTS AND DESIGN PROFESSIONALS FOR PLANNING PURPOSES ONLY. THIS DRAWING MAY NOT BE USED FOR CONSTRUCTION.
4. ALL INFORMATION CONTAINED HEREIN WAS CURRENT AT THE TIME OF DEVELOPMENT BUT MUST BE REVIEWED AND APPROVED BY THE PRODUCT MANUFACTURER TO BE CONSIDERED ACCURATE.
5. CONTRACTOR'S NOTE: FOR PRODUCT AND COMPANY INFORMATION VISIT www.CADdetails.com/info AND ENTER REFERENCE NUMBER 3354-6-612.

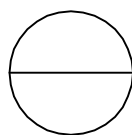

2493 SMSS

2493 SMSS SHOWN WITH OPTIONAL TEMPLATE



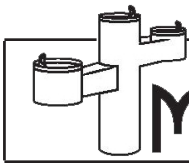

HISTORICAL DRINKING FOUNTAIN SPECIFICATIONS

WATER QUALITY (LEAD FREE)

Section 9, California Proposition 6 and the Federal Safe Drinking Water Act.

STAINLESS STEEL PEDESTAL

One piece weld construction with MDF standard 304 schedule 10 stainless steel.

RECEPTOR BOWL

18 gauge electro-polished stainless steel bowl. Bowl overlaps pedestal, preventing build-up of residue in visual drinking area. Optional stainless steel Bowl Strainer recommended for areas with sand.

BUBBLER HEAD

Stainless steel anti-squirt head (weighing a pound and a half) mounted with a lock nut and washer to prevent tampering. Lock nut pin holds bubbler in locked position to prevent twisting or turning. The MDF bubbler head has a unique design that features a steady stream trajectory and a built in natural shield from contamination.

PUSH BAR

304 stainless steel with circumference exceeding 8.6". Mushroom style push bar overlaps and prevents sand and other objects from sticking push bar in the ON position. Stainless steel bubbler housing standard.

CONTROL VALVE

Self closing valve requires less than 5 lbs to operate. Non-cartridge O-ring valve delivers steady stream of water through an adjustable valve. This valve design is to operate and function at 30 to 80 PSI. Ideal operating pressure is 60 PSI.

WATER SUPPLY (LEAD FREE)

Maintenance free reinforced nylobraid tubing - **this tubing is not plastic**. It is supplied with a 1/2" MIP threaded inlet with stainless steel strainer. Union fittings at every connection. Supply line stops above grade.

DRAIN

1 1/2" schedule 40 PVC pipe. Drain line stops above grade.

FINISH

Oven baked powder coat. Choice of colors are: green, blue, black, brown, red, yellow, orange, and white. Textured color choices: emerald, sapphire, pyrite, text-black, burgundy, gold vein, copper and sandstone. Stainless steel models are powder coated for added protection. The color chrome is available for stainless steel models only.

ACCESS

Working parts accessible through bowl of fountain for easy service. Supply and waste connections are through the above grade access door. All access plates, brackets, vandal resistant bolts and screws are stainless steel.

INSTALLATION

Surface Mount installation, is designed to be anchored on top of an existing surface (concrete, etc.) with anchor bolts through a mounting plate that is welded to the fountain. Surface Mount Fountains provided with an access door with vandal resistant stainless steel screws. Surface mount carrier recommended for all surface mount installations. Access door standard on all pedestal fountains.

WINTERIZATION

Shut off water and drain down.

WARRANTY

One year warranty, labor not included.

SHIPPING WEIGHT

Model 2400 SMSS..... 110 lbs Model 2410 SMSS..... 110 lbs
Model 2440 SMSS*.... 120 lbs Model 2493 SMSS*.... 145 lbs
*Meets ADA for High and Low

MOST DEPENDABLE FOUNTAINS, INC.™
5705 COMMANDER DR. • ARLINGTON, TN 38002-0587
www.mostdependable.com
(901)867-0039



INSTALLATION INSTRUCTIONS

Most Dependable Fountains, Inc.™

All **SM (surface mount)** products are designed to be installed on the surface of a new or existing concrete slab. Your contractor needs to provide a 1 ½” PVC drain line (**when applicable**) and water line thru finish grade. Connections are made to our SM products thru our access door, as shown on detail drawings. The water tubing is provided with a ½” male iron pipe connection. This is an excellent location for a cutoff valve. Surface Mount units are anchored to the existing concrete by means of ½” concrete shields with bolts or we recommend ½” quick bolts.

Note: We offer an optional template which is designed to be poured in the concrete slab. It comes with the necessary vandal resistant stainless steel bolts and washers needed to anchor.

All **DB (direct bury)** products are designed to be installed to a depth of 14” below grade. MDF provides 1 ½” PVC drain line inside the pedestal (**when applicable**) to point of connection by others. MDF also provides reinforced nylobraid flexible tubing with a ½” male iron pipe thread for connection to water supply by others. MDF recommends an optional valve box using a PVC conduit to the pedestal. By using this option you have complete control of your product.

Individual detail drawings available Online or by request.



For more information:

Most Dependable Fountains, Inc.™

www.mostdependable.com

Info@mostdependable.com

901-867-0039

LIMITED PRODUCT WARRANTY

Most Dependable Fountains, Inc.™

Most Dependable Fountains, Inc.™ warrants that all of its products are guaranteed against defective material or poor workmanship for a period of **one year from date of shipment**. Most Dependable Fountains, Inc.™ liability under this warranty shall be discharged by furnishing without charge any goods, or part thereof, which shall appear to the Company upon inspection to be of defective material or not of first class workmanship. Most Dependable Fountains, Inc.™ will not be liable for the cost of repairs, alterations or replacements, or for any expense connected therewith made by the owner or his agents. Most Dependable Fountains, Inc.™ will not be liable for any damages caused by defective materials or poor workmanship, except for replacements, as provided above. Buyer agrees that Most Dependable Fountains, Inc.™ has made no other warranties either expressed or implied in addition to those above stated. The products manufactured by Most Dependable Fountains, Inc.™ is warranted to function if installation and maintenance instructions provided are adhered to. The units also must be used for the purpose for which they were intended.

