

**Most
Dependable
Fountains, Inc.**

OPERATIONS MANUAL

**MODEL:
550 SMSS**

Most Dependable Fountains, Inc[™]
5705 Commander Drive
Arlington, TN 38002
901-867-0039
www.mostdependable.com

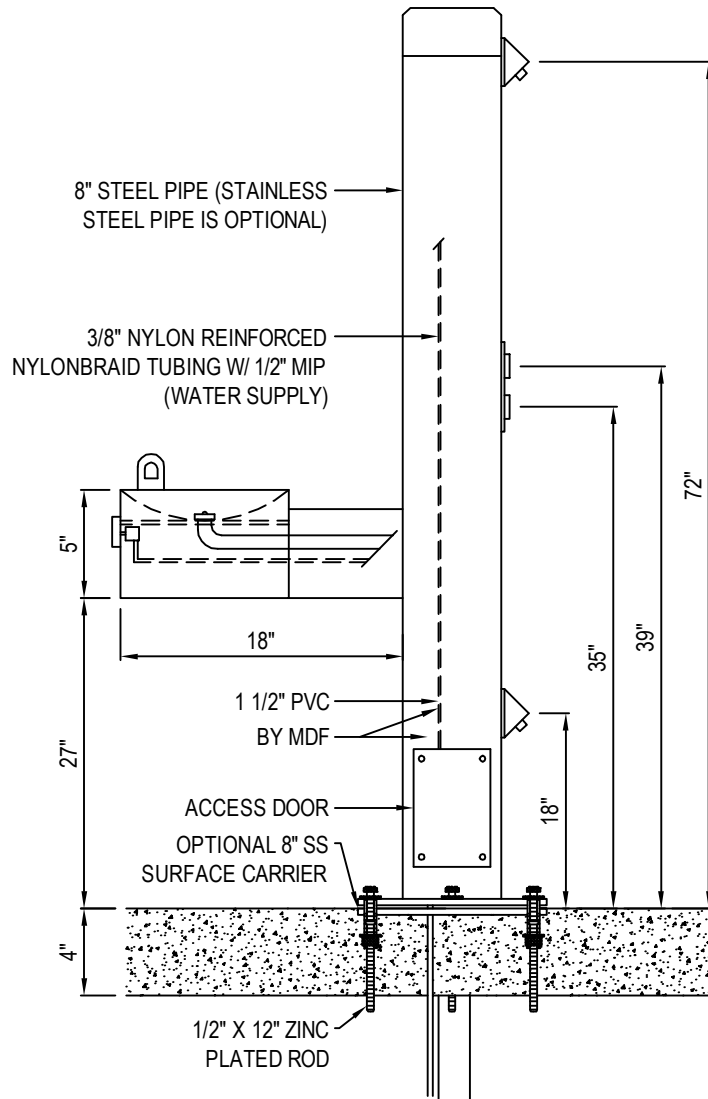

NOTES:

1. OPTIONAL STAINLESS STEEL SURFACE CARRIER RECOMMENDED ON SURFACE MOUNT INSTALLATIONS.
2. INSTALLATION TO BE COMPLETED IN ACCORDANCE WITH MANUFACTURER'S SPECIFICATIONS.
3. DO NOT SCALE DRAWING.
4. THIS DRAWING IS INTENDED FOR USE BY ARCHITECTS, ENGINEERS, CONTRACTORS, CONSULTANTS AND DESIGN PROFESSIONALS FOR PLANNING PURPOSES ONLY. THIS DRAWING MAY NOT BE USED FOR CONSTRUCTION.
5. ALL INFORMATION CONTAINED HEREIN WAS CURRENT AT THE TIME OF DEVELOPMENT BUT MUST BE REVIEWED AND APPROVED BY THE PRODUCT MANUFACTURER TO BE CONSIDERED ACCURATE.
6. CONTRACTOR'S NOTE: FOR PRODUCT AND COMPANY INFORMATION VISIT www.CADdetails.com/info AND ENTER REFERENCE NUMBER 3354-10.3.

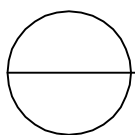

**MODEL 550 SM FOOT &
 SHOWER TOWER W/ DRINKING FOUNTAIN**

SHOWN W/ OPTIONAL 8" SS SURFACE CARRIER



Foot & Shower Tower Series Specifications

STAINLESS STEEL PEDESTAL

OR

MARINE GRADE PEDESTAL

One piece weld construction with MDF standard 304 schedule 10 stainless steel.

PUSH BAR

One piece weld construction with MDF standard Marine Grade 316 stainless steel.

SPRAY HEADS

304 stainless steel with circumference exceeding 8.6". Mushroom style push bar overlaps and prevents sand and other objects from sticking push bar in the ON position. Stainless steel bubbler housing standard.

CONTROL VALVE

1.5 GPM at 60 PSI.

Requires less than 5 lbs to operate. This valve design is to operate and function at 30 to 80 PSI. Ideal operating pressure is 60 PSI.

WATER SUPPLY (LEAD FREE)

Maintenance free reinforced nylobraid tubing — **this tubing is not plastic**. It is supplied with a 1/2" MIP threaded inlet with stainless steel strainer. Union fittings at every connection. Supply line stops above grade.

FINISH

Oven baked powder coat color choices:

- Green, Blue, Black, Red, Brown, White, Teal, Umbria Grey

Textured color choices:

- Emerald, Sapphire, Textured Black, Pyrite, Sandstone, Gold Vein, Copper

The color CHROME is an available option for Stainless Steel (SS) models only.

- Chrome

Stainless steel models are powder coated for added protection.

INSTALLATION

Surface Mount installation, is designed to be anchored on top of a new or existing surface (concrete, etc.) For a new surface, a surface mount carrier is recommended. For an existing surface, anchor bolts are to be used through the attached mounting plate. Surface Mount Fountains come standard with an access door with vandal resistant stainless steel screws.

WINTERIZATION

Shut off water and drain down.

WARRANTY

One year warranty, labor not included.

SHIPPING WEIGHT

Model 500 SMSS 100 lbs	Model 564 SMSS..... 160 lbs	Model 575 SMSS 155 lbs
Model 500 WMSS..... 120 lbs	Model 565 SMSS 185 lbs	Model 580 SMSS 200 lbs
Model 525 SMSS 45 lbs	Model 552 SMSS 200 lbs	Model 590 SMSS 175 lbs
Model 550 SMSS 170 lbs		

Above specifications apply with these notes:

- Model 500 – One shower & one foot spray.
- Model 525 – Foot Tower: one head only.
- Model 550 – One shower, one foot spray & accessible drinking fountain.
- Model 552 – One shower, one foot spray with both high & low ADA drinking fountains.
- Model 564 – Accessible shower with one metered head at 72" & a foot wash on one side & one metered accessible head at 49" on back side, with 2 grab bars.
- Model 565 – Accessible shower with one metered head at 72", one metered head at 49" & a non-metered foot wash (on same side) with 2 grab bars.
- Model 575 – Dual (back to back) shower & foot spray heads.
- Model 580 – One shower, one foot spray & trough style accessible drinking fountain.
- Model 590 – Four shower heads & one foot spray.
- Model 500-8 – Denotes custom: call for more information.

MOST DEPENDABLE FOUNTAINS, INC™

5705 Commander Dr.
Arlington, TN 38002

mostdependable.com
(901) 867-0039



INSTALLATION INSTRUCTIONS

Most Dependable Fountains, Inc.™

All **SM (surface mount)** products are designed to be installed on the surface of a new or existing concrete slab. Your contractor needs to provide a 1 ½” PVC drain line (**when applicable**) and water line thru finish grade. Connections are made to our SM products thru our access door, as shown on detail drawings. The water tubing is provided with a ½” male iron pipe connection. This is an excellent location for a cutoff valve. Surface Mount units are anchored to the existing concrete by means of ½” concrete shields with bolts or we recommend ½” quick bolts.

Note: We offer an optional template which is designed to be poured in the concrete slab. It comes with the necessary vandal resistant stainless steel bolts and washers needed to anchor.

All **DB (direct bury)** products are designed to be installed to a depth of 14” below grade. MDF provides 1 ½” PVC drain line inside the pedestal (**when applicable**) to point of connection by others. MDF also provides reinforced nylobraid flexible tubing with a ½” male iron pipe thread for connection to water supply by others. MDF recommends an optional valve box using a PVC conduit to the pedestal. By using this option you have complete control of your product.

Individual detail drawings available Online or by request.



For more information:

Most Dependable Fountains, Inc.™

www.mostdependable.com

Info@mostdependable.com

901-867-0039

LIMITED PRODUCT WARRANTY

Most Dependable Fountains, Inc.™

Most Dependable Fountains, Inc.™ warrants that all of its products are guaranteed against defective material or poor workmanship for a period of **one year from date of shipment**. Most Dependable Fountains, Inc.™ liability under this warranty shall be discharged by furnishing without charge any goods, or part thereof, which shall appear to the Company upon inspection to be of defective material or not of first class workmanship. Most Dependable Fountains, Inc.™ will not be liable for the cost of repairs, alterations or replacements, or for any expense connected therewith made by the owner or his agents. Most Dependable Fountains, Inc.™ will not be liable for any damages caused by defective materials or poor workmanship, except for replacements, as provided above. Buyer agrees that Most Dependable Fountains, Inc.™ has made no other warranties either expressed or implied in addition to those above stated. The products manufactured by Most Dependable Fountains, Inc.™ is warranted to function if installation and maintenance instructions provided are adhered to. The units also must be used for the purpose for which they were intended.



Color Options

SMOOTH: Available for Standard & Stainless Steel Units



Green



Blue

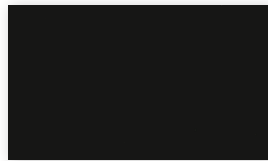

Black



Red

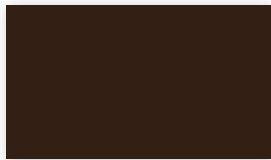

Brown

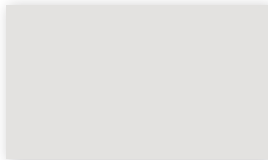

White



Teal



Umbria Grey

TEXTURED: Available for Standard & Stainless Steel Units

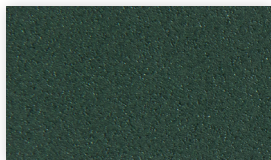

Textured Emerald

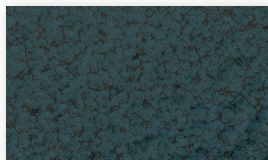

Textured Sapphire



Textured Black

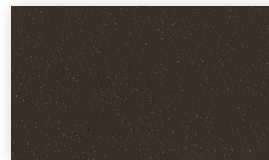

Textured Pyrite

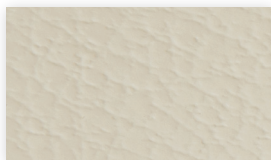

Textured Sandstone

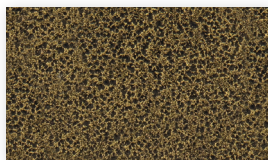

Textured Gold Vein

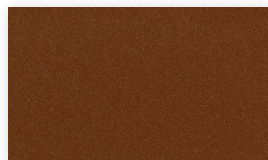

Textured Copper

CHROME: Available for Stainless Steel Units Only

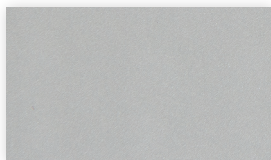

Chrome

* Colors featured are stock colors. Color samples are replications of actual finishes and may vary slightly.